

# CS UNITEC, INC.

22 Harbor Avenue  
Norwalk, CT 06850

Website: [www.csunitec.com](http://www.csunitec.com)

Email: [info@csunitec.com](mailto:info@csunitec.com)

## Model END 130/3 PO – Core Drill

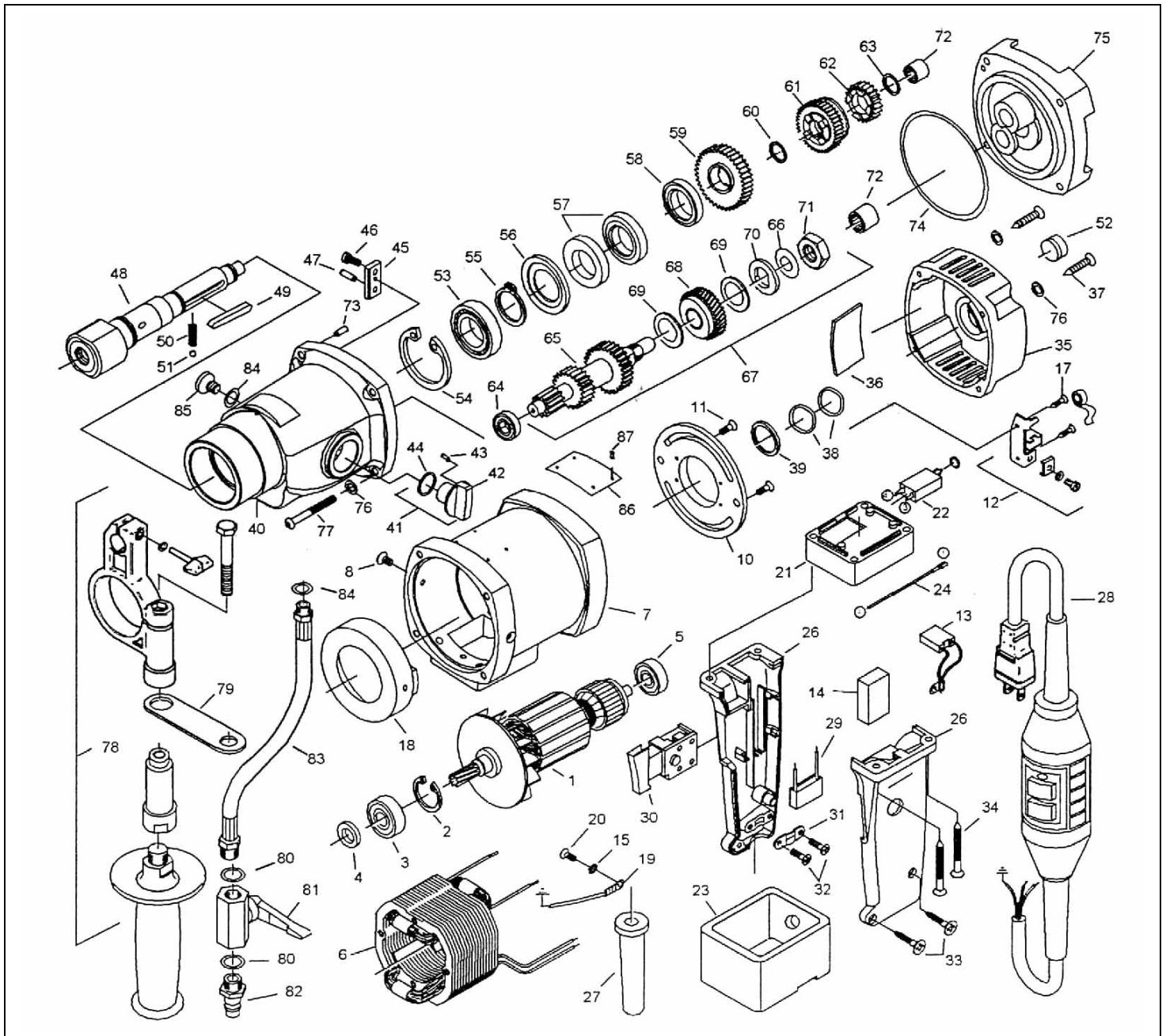

*Prices to change without notice.  
Not responsible for typographical errors.*

<b>POS. NO.</b>	<b>ITEM NO.</b>	<b>DESCRIPTION</b>	
1	73332100	Armature	
2	80201333	Safety Ring 28/1.2	Replaces 050.0166
3	80410032	Ball Bearing	See 114 146
4	83000075	Shaft Seal	
5	80410021	Ball Bearing	See 100 579
6	73338150	Stator, Complete	
7	73331203	Motor Housing Isol.	
8	80201226	Screw	
10	80901010	Holder	
11	80201182	Screw	
12	80201199	Carbon Brush Holder	
13	80700040	Carbon Brush	Replaces 8070019
14	73320210	Contact Washer	
15	80200752	Washer	
17	80201251	Screw	
18	73331140	Air Guiding Ring	
19	73331185	Strand	
20	80201200	Screw	
21	73338290	Intermediate Block	
22	80500019	Overload Switch	
23	73331266	Handle for Protection	
24	73116186	Interconnection Wire	
26	80900097	Pair of Handle Halfs	
27	83000004	Cable Sleeve	
28	73338262	Connecting Lead, complete with	PRCD
29	80500010	Condensor-SEE #80500014	
30	80600143	Switch	
31	80900022	Strain Relief Clamp	
32	80201270	Screw	
33	80201271	Screw 4.2x16	
34	80201207	Screw	
35	73331240	Bearing Cap	
36	73331210	Cap	
37	80201204	Screw	
38	80200702	Spring	
39	83000090	O-Ring	
40	73331400	Gearbox Housing	
41	73331545	Gear Change Complete	
42	80300108	Switch button	
43	80200577	Cylindrical Pin	
44	83000036	O-Ring	Replaces 050.0116
45	73331542	Gear Changing Lever	
46	80201330	Cylinder Head Screw	
47	80200579	Cylindrical Pin	
48	73331420	Shaft	

CS Unitec, Inc.

22 Harbor Ave, Norwalk, CT 06850

Telephone: 203-853-9522 Toll Free: 800-700-5919 Fax: 203-853-9921

WebSite: [www.csunitec.com](http://www.csunitec.com) E-Mail: [info@csunitec.com](mailto:info@csunitec.com)

*Prices to change without notice.  
Not responsible for typographical errors.*

<b>POS. NO.</b>	<b>ITEM NO.</b>	<b>DESCRIPTION</b>	
49	80200612	Fitting Key	See 254 046
50	80200698	Spring, 0.5 x 3.8 x 8.0 x 5.5	
51	80410082	Ball	
52	85000153	Leveling Indicator	
53	80410061	Ball Bearing	See 223 158
54	80201336	Locking Ring	
55	80201327	Locking Ring	
56	73331425	Distance Ring	
57	83000076	Shaft Seal	
58	83000077	Shaft Seal	
59	73331460	Gear	
60	80200746	Seeger Ring	
61	73331550	Control Gear	
62	73331470	Gear	
63	80200747	Seeger Ring	
64	80410015	Ball Bearing	See 9 1001 0090
65	73331490	Intermediate Shaft	
66	80200716	Spring Washer	
67	73331493	clutch	
68	73331560	Gear with Bushing	Replaces 73331495
69	73331499	Clutch Washer	
70	73331496	Driving Washer	
71	80201011	Nut	
72	80420115	Needle Bearing	
73	80200582	Notched Pin	Replaces 032.0211
74	83000089	O-Ring	
75	73331610	End Shield of Gearing	
76	80201302	Spring Ring	
77	80201231	Spring Ring	
78	73331695	Additional Handle Complete	
79	73427270	Fastening Plate	
80	251 648	Valve Ring-#52662&65205	#9 2126 0140 & 9 2126 0120
81	251 646	Water Valve	
82	83000124	Gardena Connector	
83	83000109	Hose Complete	
84	83000106	Seal	
85	80201406	Screw	
87	80200594	Notched Pin 2 x 3	

CS Unitec, Inc.

22 Harbor Ave, Norwalk, CT 06850

Telephone: 203-853-9522 Toll Free: 800-700-5919 Fax: 203-853-9921

WebSite: [www.csunitec.com](http://www.csunitec.com) E-Mail: [info@csunitec.com](mailto:info@csunitec.com)