

DIAMOND CORE DRILLING





Model	Catalog page	Wet/Dry drilling	Spindle connection	Power input	Load speed
DRY CORE DRILLING					
EHD 2000 S 	26	 up to 6" dia.	5/8" x 11 UNC	13.6 Amp/ 110 Volt	0-1,000/ 0-2,000 rpm
WET/DRY CORE DRILLING					
ETN 2001 P 	28	 up to 4" dia.  up to 4" dia.	5/8" x 11 UNC 1 1/4" x 7 UNC	15 Amp/ 110 Volt	0-800/ 0-1,570 rpm
ETN 162/3 	30	 up to 6 3/8" dia.  up to 8" dia.	5/8" x 11 UNC 1 1/4" x 7 UNC	19.5 Amp/ 110 Volt	0-510/ 0-1,150/ 0-2,500 rpm
WET CORE DRILLING					
END 712 P 	32	 5/32" to 3/4" dia.	M 12 x 1.5 male	6 Amp/ 110 Volt	0-8,000 rpm
END 1550 P 	34	 1/4" to 2 5/8" dia.	Quick-Lock Connector 5/8" x 11 UNC	13 Amp/ 110 Volt	1,800- 4,400 rpm
END 130/3.1 PO 	36	 up to 6" dia.	5/8" x 11 UNC 1 1/4" x 7 UNC	15 Amp/ 110 Volt	600/ 1,300/ 2,800 rpm
CORE DRILL MOTORS					
EBM 352/3 	39	 up to 14" dia.	1 1/4" male	20 Amp/ 110 Volt	230/ 500/ 1,030 rpm
PLD 450 B 	39	 up to 18" dia.	1 1/4" male	30 Amp/ Circuit/ 110 Volt	190/ 400/ 840 rpm
CORE DRILLING UNITS					
DBE 160 	43	 up to 6" dia.	5/8" and 1 1/4" x 7 UNC	18 Amp/ 110 Volt	450 rpm
ETN 162/3 PSA & ETN 162/3 PSV 	44	 up to 6 3/8" dia.  up to 8" dia.	5/8" x 11 UNC & 1 1/4" x 7 UNC	19.5 Amp/ 110 Volt	0-510/ 0-1,150/ 0-2,500 rpm
EBM 352/3 PSA & EBM 352/3 PSV 	46	 up to 14" dia.	1 1/4" male	20 Amp/ 110 Volt	230/ 500/ 1,030 rpm
PLD 450 SA 	47	 up to 18" dia.	1 1/4" male	30 Amp/ 110 Volt	190/ 400/ 840 rpm

230 Volt machines are also available



FEATURES OF DIAMOND CORE DRILLS

With the widest range of diamond core drills, CS Unitec and EIBENSTOCK have models for cutting holes from 5/32" to 18" dia. in floors, walls and ceilings. Fast drilling of reinforced concrete, concrete, brick, block and stone with hand-held and rig-mounted wet and dry models. Ideal for professional drilling applications, EIBENSTOCK core drills are powerful and reliable and are available with a wide range of accessories.



Diamond dry core drill EHD 2000 S



**INCLUDED
5/8" ADAPTER**



The universal tool for installation holes up to Ø 6"

USE:

- Dry drilling up to 6" in internal brick, brickwork, blockwork and other abrasive materials
- Creating wall and roof openings for plumbing, heating and ventilation installations
- For electrical installation work including switches and sockets

FEATURES:

- Electronic – soft start, temperature control and overcurrent cut-off
- Powerful 2-speed gearbox
- Mechanical safety clutch
- Additional handle – variable adjustment for operator comfort and safety

DIAMETER



DRY



GEARS



SPECIFICATIONS	MODEL NO. EHD 2000 S
Power input	13.6 Amp
Rated voltage	110V ~
Load speed	0-1,000/0-2,000 rpm
No-load speed	1,500/3,000 rpm
Drilling diameter	holes up to 6" dia.
Spindle connection	M 18 male + 5/8" x 11 UNC
Collar diameter	52mm
Weight	13 lbs.

Supplied

in a case without accessories



Concrete and stone drilling, grinding and sawing machines, when used with dust collection vacuums and accessories, offer additional protection to the operator. Users of this equipment should follow all OSHA and safety regulations. See page 101.





WITHOUT DUST EXTRACTION

Material



for brickwork, soft concrete

Diamond dry drill bits



Ø 1" to Ø 6"

Adapter

5/8" x 11 - M 18

35512000



**See pages 50-52 for
Diamond Core Drill Bits**

DIAMOND CORE DRILLING

WITH DUST EXTRACTION H

Material



for brickwork, soft concrete

**Centering shaft
spring loaded**



35612000

Drill bit for socket outlets Dry M 16



Length 2 3/4" (70mm)
Ø 2 3/4" and Ø 3 1/4"

**Dust
extraction**



M 16 - M 18

35240000

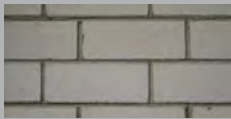

for sand-lime brick

**Centering shaft
spring loaded**



35612000



Length 2 3/4" (70mm)
Ø 2 3/4" and Ø 3 1/4"

WITH DUST EXTRACTION M 18 - 1 1/4"

Material



for brickwork,
sand-lime brick

Diamond dry drill bits 1 1/4" x 12 UNF



Length 9" (228mm)
Ø 1" to Ø 6"

**Dust
extraction**



1 1/4" x 12 UNF - 5/8" - 11 UNC

4400125

Diamond drill bits see page 50-52

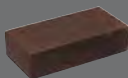

**Sharpening block
8" x 4" x 2"**

35910000



Copper ring 1 1/4"
for easy removal of the drill bit

35450000 1 piece



**Industrial Wet/Dry Dust Collec-
tion Vacuums – See page 101**

**HEPA
Filtration**

CS 1225 H
6.6 Gals.

CS 1500 H
13 Gals.

CS 1445 H
9 Gals.

**Standard
Filtration**

CS 1225
6.6 Gals.

CS 1500
13 Gals.

CS 1445
9 Gals.



Diamond wet-dry core drill ETN 2001 P

Easy to use for holes up to Ø 4"

USE:

- Dry drilling in sand-lime brick, brickwork, clinker, brick and other abrasive materials as well wet drilling in reinforced concrete, natural stone and asphalt
- Plumbing, heating and ventilation construction, civil engineering, landscape construction

FEATURES:

- Electronic – soft start, temperature control and GFCI overcurrent cut-off, optical overload indication
- 2-speed oil bath gearbox – optimal lubrication
- Mechanical safety clutch
- Water supply on the gearbox extension
- Use for wet and dry drilling
- Additional handle – variable adjustment on the collar



**INCLUDED
5/8" & 1 1/4"
ADAPTERS**

DIAMETER



WET/DRY



GEARS



SPECIFICATIONS

MODEL NO. ETN 2001 P

Power input	15 Amp
Rated voltage	110 V ~
Load speed	0-800/0-1,570 rpm
No-load speed	1,100/2,300 rpm
Drilling diameter	free hand up to 3 1/4" with drill rig up to 4"
Spindle connections	M 18 male + 5/8" x 11 UNC + 1 1/4" x 7 UNC
Collar diameter	52mm
Weight	15 lbs.

Supplied

in a case without accessories



External water supply – easy to service



Concrete and stone drilling, grinding and sawing machines, when used with dust collection vacuums and accessories, offer additional protection to the operator. Users of this equipment should follow all OSHA and safety regulations. See page 101.



FOR WET DRILLING

Material



for reinforced concrete



for reinforced concrete

Diamond wet drill bits 5/8" UNC



12" drilling depth

Diamond wet drill bits 1 1/4"



12" drilling depth

Centering device with water collection
max. Ø 3 1/4"

35849000

Combination adapter

5/8" x 11 UNC, M 18

35110000

1 1/4" x 7 UNC, M 18

35112000



Water suction ring

Hand-Held: **35875**

For BST 104 Stand: **35897**

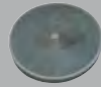

Spare seals

for water suction ring

79RK4955

**See pages 50-52 for
Diamond Core Drill Bits**

FOR DRY DRILLING WITH DUST EXTRACTION 1 1/4"

Material



for brickwork,
sand-lime brick

Diamond dry drill bits 1 1/4" x 12 UNF



12" drilling depth

Dust extraction



1 1/4" x 12 UNF - 5/8" x 11 UNC

4400125



**Water Recycling Vacuum – See
page 108**

Model CS 2000 vacuums slurry and
debris, separates water and pumps
clean water back to tool. Enables
easy disposal of slurry.

**Industrial Wet/Dry Dust Collection
Vacuums – See page 101**

HEPA Filtration	Standard Filtration
CS 1225 H 6.6 Gals.	CS 1225 6.6 Gals.
CS 1500 H 13 Gals.	CS 1500 13 Gals.
CS 1445 H 9 Gals.	CS 1445 9 Gals.



Water tank

3 gallon with 3 ft. hose and
Gardena Connector

251.623

Diamond drill bits see page 50-52

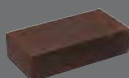

Sharpening block
8" x 4" x 2"

35910000



Copper ring 1 1/4"
for easy removal of the drill bit

35450000 1 piece



Guide ring for centering device
Please name order no. + Ø

358410 ... + 1", 1 1/4", 1 1/2", 1 5/8", 2", 2 1/4", 2 3/4", 3 1/4"



Drill rig BST 104/60

Specifications
see page 41



Diamond wet-dry core drill ETN 162/3



**INCLUDED
5/8" ADAPTER**

DIAMETER



WET/DRY



GEARS



SPECIFICATIONS

MODEL NO. ETN 162/3

Power input	19.5 Amp
Rated voltage	110 V ~
Load speed	0-510/0-1,150/0-2,500 rpm
Drilling diameter	Concrete (wet)
	1. Gear 3 1/4"-6 3/8"*
	2. Gear 1 3/4"-3 1/4"
* with drill rig	Brickwork (dry)
	1. Gear 4 3/4"-8"
	2. Gear 2 1/4"-4 3/4"
3. Gear 1/2"-2 1/4"	
Spindle connection	5/8" x 11 UNC & 1 1/4" x 7 UNC
Collar diameter	60mm
Weight	15 lbs.

Supplied

in a molded carrying case with water swivel and dust extraction, open wrench SW 32 + 41

The versatile drill for drilling up to Ø 6-3/8" in concrete (up to 3" by hand and 6-3/8" with drill stand)

USE:

- Dry drilling in sand-lime block, brick and other abrasive materials
- Wet drilling in reinforced concrete, natural stone and asphalt
- Plumbing, heating and ventilation construction, civil engineering, landscape construction

FEATURES:

- Newly developed, powerful 2,200 W motor, with high power reserves and a long lifetime
- Electronic - soft start, temperature control and GFCI overcurrent cut-off, optical overload indication, constant speed
- Service-LED - letting you know when the carbon brushes need changing (continues working approx. 10 working hours before shutdown)
- 3 speed oil bath gearbox - for optimal lubrication in all working positions, due to the newly developed oil pump
- Mechanical safety clutch
- Combination spindle with integrated connection for centering rod - fast, precise spot drilling
- Ergonomic handle with large switch for control and comfortable drilling
- Changing system - fast conversion between wet and dry applications
- Integrated level indicator on motor and handle
- Quick-mounting system - attach the machine to BST 182 V/S without any tools



Concrete and stone drilling, grinding and sawing machines, when used with dust collection vacuums and accessories, offer additional protection to the operator. Users of this equipment should follow all OSHA and safety regulations. See page 101.



FOR WET DRILLING

Material



for reinforced concrete



for reinforced concrete



Water suction ring
Hand-Held: **35875**
For BST 104 Stand: **35897**



Spare seals
for water suction ring
79RK4955

**Diamond wet drill bits 5/8" UNC
12" Drilling Depth**



**Diamond wet drill bits 1 1/4" UNC
12" Drilling Depth**



Special Sizes Available

**See pages 50-52 for
Diamond Core Drill Bits**

Centering device with water collection
max. Ø 3 1/4"

3584C000



FOR DRY DRILLING WITH DUST EXTRACTION

Material



for brickwork,
sand-lime brick

**Dry diamond vacuum drill bits
1 1/4" x 12 UNF**



Length 9", Ø 3 1/4"-8"

**Dust
extraction**



1 1/4" x 12 UNF - 5/8" - 11 UNC
4400125



**Water Recycling
Vacuum – See page 108**
Model CS 2000 vacuums
slurry and debris,
separates water and
pumps clean water back
to tool. Enables easy
disposal of slurry.

**Industrial Wet/Dry Dust Collection
Vacuums – See page 101**

HEPA Filtration	Standard Filtration
CS 1225 H 6.6 Gals.	CS 1225 6.6 Gals.
CS 1500 H 13 Gals.	CS 1500 13 Gals.
CS 1445 H 9 Gals.	CS 1445 9 Gals.



Water tank
3 gallon with 3 ft. hose and
Gardena Connector
251.623

Diamond drill bits see page 50-52



Sharpening block
8" x 4" x 2"
35910000

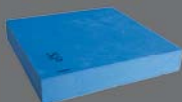

Sharpening plate
12 5/8" x 12 5/8" x 2 1/4"
35913000



Copper ring 1 1/4"
for easy removal of the drill bit
35450000 1 piece



Guide ring for centering device
Please name order no. + Ø
358410 ... + 1", 1 1/4", 1 1/2", 1 5/8", 2", 2 1/4", 2 3/4", 3 1/4"



Drill rig BST 182 V/S
Specifications
see page 42

**Set: ETN 162/3 + BST 182 V/S
= ETN 162/3 PSA**
Specifications
see page 44



Diamond wet "Mini Core" drill END 712 P



The fast model for up to Ø 3/4"

USE:

- Wet drilling in natural stone, tiles, ceramics, porcelain, stoneware, glass, concrete
- Blind or through holes for anchors and pipe, as well as gravestones and countertops
- Dowel holes
- Tilers, stonemasons and installation companies

FEATURES:

- Electronic switch – stepless speed control
- GFCI for overcurrent protection
- Optimal concentricity
- Integrated water supply
- Easy to service – shaft seals are easily replaceable
- Water supply control – on/off, stepless quantity control
- Lightweight, ergonomic design – easy handling
- Centering device (accessory)

DIAMETER



WET



GEARS



SPECIFICATIONS	MODEL NO. END 712 P
Power input	6 Amp
Rated voltage	110 V ~
Load speed	0-8,000 rpm
No-load speed	11,000 rpm
Max. drilling diameter	5/32" to 3/4"
Spindle connection	M 12 x 1.5 male
Weight	5 lbs.
Supplied	in a molded carrying case with depth gauge, and keyless chuck



Starter kit no. END 712 PC (shown above) includes drill, centering device with drilling template, water suction hose with Gardena-Connector, diamond wet full drill bits 1/4", 5/16", & 3/8", sharpening block



FOR WET DRILLING

Material



for concrete, tiles

**Centering device with
drilling template**



3583A000

Diamond wet drill bits



Ø 5/32 - 3/8"

**Keyless chuck
FFS - M12 - 16**



for natural stone,
stoneware

**Centering device with
drilling template**



3583A000

Diamond wet drill bits



Ø 1/2 - 3/4"

END 712 P Unicore Wet Diamond Bits

Order No.	Specifications
FF-040851	5/32" dia. x 1.6" depth
FF-050951	3/16" dia. x 1.6" depth
FF-065951	1/4" dia. x 2" depth
FF-080951	5/16" dia. x 2" depth
FF-101056	3/8" dia. x 2.4" depth
FF-121306	1/2" dia. x 3.2" depth
FF-161306	5/8" dia. x 3.2" depth
FF-201306	3/4" dia. x 3.2" depth



Water suction hose

35837000



**Water Recycling Vacuum – See
page 108**

Model CS 2000 vacuums slurry and debris, separates water and pumps clean water back to tool. Enables easy disposal of slurry.



**Industrial Wet/Dry Dust Collection
Vacuums – See page 101**

HEPA Filtration	Standard Filtration
CS 1225 H 6.6 Gals.	CS 1225 6.6 Gals.
CS 1500 H 13 Gals.	CS 1500 13 Gals.
CS 1445 H 9 Gals.	CS 1445 9 Gals.



Water tank

3 gallon with 3 ft. hose and Gardena Connector

251.623

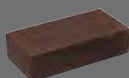

Sharpening block

8" x 4" x 2"

35910000



Diamond wet core drill END 1550 P



**INCLUDED
5/8" ADAPTER**



DIAMETER



WET



GEARS



SPECIFICATIONS	MODEL NO. END 1550 P
Power input	13 Amp
Rated voltage	110 V ~
Load speed	1,800-4,400 rpm
Drilling diameter	¼" to 2 5/8"
Spindle connection	Quick change adapter and 5/8" x 11 UNC adapter
Weight	7 lbs.

Supplied

in a molded carrying case with bayonet quick changing adapter G½" - 5/8" UNC and garden coupling

The versatile model for up to Ø 2 5/8" holes

USE:

- Wet drilling in natural stone, tiles, ceramic, porcelain, stoneware, glass and reinforced concrete
- Blind or through holes for fitting connectors as well as gravestones and worktops
- Anchor and mounting holes
- Ideal for construction, installation, natural stone and tiling applications

FEATURES:

- Electronics – variable-speed drilling without shock, dust and vibration
- GFCI for overcurrent protection
- Stainless steel spindle for corrosion-free wet operation
- Water supply control – on/off, stepless quantity control
- Quick-change system
- Can be used with drill rig BST 50V to keep stationary
- Centering device (accessory)

Speed regulation



Water supply control



FOR WET DRILLING

Material



for natural stone, tiles



for natural stone



for reinforced concrete



for concrete



for natural stone, tiles

Diamond wet drill bits 5/8" UNC



Bayonet shank



Diamond wet drill bits 5/8" x 11



Diamond wet drill bits

Ø 5/32 - 5/16"

Diamond wet drill bits

Ø 1/2 - 3/4"

**Spare seals
for centering device**

35842000



**Quick change
adapter**

G 1/2" - G 1/2"

38004000

**Quick change
adapter**

5/8" - G 1/2"

258.992

Adapter + Chuck

M 12 x 1.5 - G 1/2"

35122000

Keyless chuck

FFS - M12 - 16

**Centering device
with water collection
(Gardena-Connector)
max. Ø 1"**

35836000



**Water suction ring
WR 82**

3587R000



**Centering device
with drilling template**

3583A000



Water suction hose

35837000



Water tank

3 gallon with 3 ft. hose and Gardena Connector

251.623



Industrial Wet/Dry Dust Collection Vacuums – See page 102

HEPA Filtration

CS 1225 H, 6.6 Gals.

CS 1500 H, 13 Gals.

CS 1445 H, 9 Gals.

Standard Filtration

CS 1225, 6.6 Gals.

CS 1500, 13 Gals.

CS 1445, 9 Gals.



**Water Recycling Vacuum
– See page 108**

Model CS 2000 vacuums slurry and debris, separates water and pumps clean water back to tool. Enables easy disposal of slurry.

Diamond drill bits see page 50-52

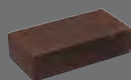

**Sharpening block
8" x 4" x 2"**

35910000



**3 Spare seals
for quick change adapter**

35125000



**Guide ring for centering device
please name order no. + Ø**

358400... + 1/4", 1/2", 5/8", 3/4", 1"



Drill rig BST 85

Drill rig BST 50 V

specifications
see page 41



Diamond wet core drill END 130/3.1 PO



**INCLUDED
5/8" & 1 1/4"
ADAPTERS**

DIAMETER

Ø6"

WET



GEARS



The compact, robust 3-speed drill for up to Ø 6" in concrete

USE:

- Wet drilling in reinforced concrete, natural stone and asphalt especially for narrow, difficult accessible places, e.g. in pits
- Aluminium housing suitable for civil engineering
- Sanitary, heating and ventilation construction, civil engineering, landscape construction

FEATURES:

- Overload temperature control and GFCI overcurrent cut-off, optical overload indication
- Cut-off carbon brushes – protects the motor
- 3-speed oil bath gearbox – optimal lubrication
- Short compact design
- Complete aluminium housing
- Integrated level bubble on motor and handle
- Side handle with connection for centering device or water collection

SPECIFICATIONS	MODEL NO. END 130/3.1 PO
Power input	15 Amp
Rated voltage	110 V ~
Load speed	600/1,300/2,800 rpm
No-load speed	1,000/2,200/4,300 rpm
Drilling diameter	1. Gear 3 1/4"-6"*
* with drill rig	2. Gear 1 3/4"-3 1/4"
	3. Gear 1/2"-1 3/4"
Spindle connection	5/8" x 11 UNC & 1 1/4" x 7 UNC
Collar diameter	60mm
Weight	16 lbs.

Supplied

in a molded carrying case with water swivel and wrenches SW 32 + 41



Drill rig BST 104/60
specifications
see page 41



Concrete and stone drilling, grinding and sawing machines, when used with dust collection vacuums and accessories, offer additional protection to the operator. Users of this equipment should follow all OSHA and safety regulations. See page 101.



FOR WET DRILLING

Material



for reinforced concrete



for reinforced concrete



for concrete-sewer pipe



Water suction ring

Hand-Held: **35875**
For BST 104 Stand: **35897**



Spare seals

for water suction ring
79RK4955



**Water Recycling Vacuum –
See page 108**

Model CS 2000 vacuums slurry and debris, separates water and pumps clean water back to tool. Enables easy disposal of slurry.

**Diamond wet drill bits 5/8" UNC
12" Drilling Depth**



**Diamond wet drill bits 1 1/4" UNC
12" Drilling Depth**



**Diamond wet drill bits 1 1/4" UNC
for Concrete Pipe
5-1/2" Drilling Depth**



36B166 6.50" dia. (166 mm)
36B186 7.30" dia. (186 mm)
36B200 7.80" dia. (200 mm)

**Pipe drilling stand
RBS 200**



09651000

collar Ø 2 3/8"
max. drilling Ø 8"

**Centering device with water collection
max. Ø 3 1/4"**

35847000



**Industrial Wet/Dry Dust Collection
Vacuums – See page 101**

HEPA Filtration	Standard Filtration
CS 1225 H 6.6 Gals.	CS 1225 6.6 Gals.
CS 1500 H 13 Gals.	CS 1500 13 Gals.
CS 1445 H 9 Gals.	CS 1445 9 Gals.



Water tank

3 gallon with 3 ft. hose and Gardena Connector

251.623

Diamond drill bits see page 50-52



Sharpening block
8" x 4" x 2"

35910000

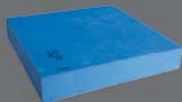

Sharpening plate
12 5/8" x 12 5/8" x 2 1/4"

35913000



Copper ring 1 1/4"
for easy removal of the drill bit

35450000 1 piece



Guide ring for centering device
Please name order no. + Ø

358410 ... + 1", 1 1/4", 1 1/2", 1 5/8", 2", 2 1/4", 2 3/4", 3 1/4"



Drill rig BST 104/60

specifications see page 44



FEATURES OF CORE DRILL MOTORS

Our core drills have a solid and sturdy construction and can be mounted to a variety of drill rigs.

TWO POWERFUL MOTORS



DIAMOND CORE DRILLING

	EBM 352/3	PLD 450 B
Power input	20 Amp / 110 Volt	30 Amp Circuit / 110 Volt
Load speed	230/500/1,030 rpm	190/400/840 rpm
Drilling diameter	up to 14"	up to 18"
Spindle connection	5/8" x 11 UNC 1 1/4" x 7 UNC	5/8" x 11 UNC 1 1/4" x 7 UNC
Machine connection to stand	Universal tool holder/Slide mount	Universal tool holder/Slide mount
Weight	27.5 lbs. (motor only)	28 lbs. (motor only)
Model no.	EBM 352/3P	PLD 450
Supplied	in a box with open end wrench SW 32 + 41	in a box with open end wrench SW 32 + 41

***Drill up to 18" dia. in
concrete, brick, block,
natural stone and more.***





Machine connection

can be used with drill motors of various brands
 - Quick-mounting system
 - Universal tool holder
 - Collar connection

Scale

easy adjustment of drilling depth

Tooth track

wide and constant, precise, long-lived

Aluminium colum

high torsional strength, light, 45° swivel

Adjusting screws

robust, exact adjustment

Hole centre indicator

exact positioning

Guides/bearings

smooth running, hard-wearing, adjustable

Spirit level

easy to level

Feed lever

change without any tool, easy selection of the operating side

Additional handle*

easy transport

Rollers*

quick to mount, easy and light transport

** not present on all models*

Base

- Space saving base (anchor)
 - Combined base (anchor or vacuum)
 - Special mounting (manual with two suction cups)

FEATURES OF DRILL RIGS

Our assortment of drill rigs and accessories that were developed and produced with EIBENSTOCK can be used for a variety of tasks, including drilling holes up to 18". The drill rigs are very light and easy to handle and can be used by a wide spectrum of the construction industry; from civil engineering and professional drilling companies to plumbers and electricians.



	BST 50 V*	BST 85	BST 104/60 V*	BST 162 V*
For model nos.	END 1550 P	END 1550 P* ¹ ETN 2001 P* ¹	ETN 2001 P* ¹ ETN 152 END 130/3.1 PO	ETN 2001 P* ¹ END 130/3.1 PO ETN 152 ETN 162
Max. drilling Ø at 90°	2 ¾"	4" Vacuum 1 ¾"	5 ¼"	6"
Column length* ¹	11 ¼"/aluminum	26 ¾"/aluminum	26 ¾"/aluminum	33 ½"/aluminum
Quick-mounting system	-	-	-	-
Universal tool holder	-	-	-	-
Collar mounting	Ø 53mm	Ø 60mm	Ø 60mm	Ø 60mm
Adjustable Angle	-	45° to 90°	45° to 90°	45° to 90°
Weight	15 lbs.	15.4 lbs.	18.7 lbs.	23.1 lbs
Space saving base (anchor)	-	-	12 ⅝" x 9"	12 ⅝" x 9"
Combined base (anchor/vacuum)	-	9 ¼" x 6 ¾"* ² (anchor only)	anchor/vacuum	anchor/vacuum
Special mounting	2 suction cups (manual)	-	-	-

* with braces *¹ Requires reducer ring #35820000 *² Vacuum set necessary - special accessory

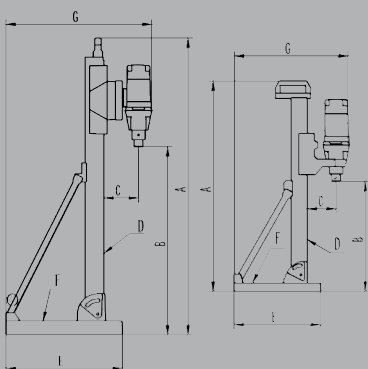

dimensions	DBE 160	ETN 162	EBM 352	PLD 450 B
A	33 ⅔"	41 ⅓"	43 ⅜"	44"
B	21"	27 ⅔"	27 ⅕"	24 ⅝"
C	4 ⅞"	5"	8"	9 ½"
D profile	1 ⅝"x2 ⅔"	1 ⅝"x2 ⅔"	2 ¾"x2 ¾"	2 ⅜"x2 ⅜"
E	9"	13"	21 ¼"	11 ½"
F base plate width	6 ⅞"	9 ⅘"	13 ⅝"	7 ⅝"
G	14 ⅜"	20"	29"	22 ½"



	BST 182 V/S*	BST 300*	BST 300 V*	BST 352 V*	PLB 450*	PLB 450 ST*
For model nos.	ETN 162/3	EBM 350	EBM 350	EBM 352/3	PLD 450 B	PLD 450 B
Max. drilling Ø at 90°	8"	13 ¾"	13 ¾"	14"	18"	19 ¾"
Column length*1	39 ¼" / aluminium	39 ¼" / aluminium	39 ¼" / aluminium	39 ¼" / aluminium	39 ¼" / steel	39 ¾" / steel
Quick-mounting system	x	-	-	-	-	-
Universal tool holder	-	x	x	x	x	x
Collar mounting	-	-	-	-	-	-
Max. inclination	45°	45°	45°	45°	45°	45°
Weight	31 lbs.	40.8 lbs.	45.2 lbs.	49.6 lbs.	45.1 lbs.	59.5 lbs.
Space saving base (anchor)	-	17" x 13" (anchor only)	-	-	11 ½" x 7 ⅝" (anchor only)	12 ¼" x 11 ¾" (anchor only)
Combined base (anchor/vacuum)	13" x 9 ¾" *2 anchor/vacuum	-	20 ½" x 13" anchor/vacuum	15 ¾" x 12 ¼" *2 anchor/vacuum	-	-
Special mounting	-	-	-	-	-	-

* with braces *1 other lengths on request *2 Vacuum set necessary - special accessory

Machine connection:

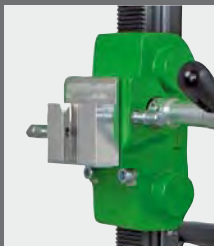

Quick-mounting system



Universal tool holder



Collar mounting

Specifics:



BST 50 V:
Swivel range 360°



BST 182 V/S and BST 352 V:
mounted carriage on 4 special balls

The compact unit for drilling up to Ø 6"

USE:

- Wet drilling in reinforced concrete, natural stone and asphalt
- Plumbing, mechanical and electrical construction, as well as civil engineering and landscape construction

FEATURES:

- Powerful, 18 Amp motor
- Switch with GFCI overcurrent cut-off protection against overloading of the motor
- Cut-off carbon brushes – protection of the motor
- 1-speed oil bath gearbox – optimal lubrication
- Mechanical safety clutch
- Integrated water supply
- Stainless steel combination spindle for connecting to 5/8" and 1¼" drill bits
- Motor and rig as a complete unit
- Handy, robust and economical
- Space-saving, compact drilling unit – lightweight



SPECIFICATIONS	MODEL NO. DBE 160
Power input	18 Amp
Rated voltage	110 V ~
Load speed	450 rpm
No-load speed	700 rpm
Max. drilling diameter	6"
Spindle connection	5/8" and 1¼" x 7 UNC
Column length	31"
Hub	21 ¾"
Weight	34 lbs.

Supplied

in a box with open wrench
SW 32 + 41, without drill bit



See pages 50-52 for
Diamond Core Drill Bits



The versatile combination for drilling up to $\text{\O} 6 \frac{3}{8}$ " with drill stand

USE:

- Wet drilling in reinforced concrete, natural stone and asphalt
- Dry drilling in limestone, brick, block and other abrasive materials
- Plumbing, mechanical and electrical construction, as well as civil engineering and landscape construction

FEATURES:

- Electronic – soft start, temperature control and overcurrent cut-off, optical overload indication, constant speed
- Service-LED – lets you know when the carbon brushes need changing (works for approx. 10 working hours before shutdown)
- 3 speed oil bath gearbox – for optimal lubrication in all working positions, due to the newly developed oil pump
- Mechanical safety clutch
- Combination spindle with integrated connection for centering rod – fast, precise spot drilling
- Changing system – fast conversion between wet and dry applications
- Integrated leveling indicator on the machine, as well as an additional handle and hole center indicator allow for exact drilling
- Quick-mounting system – apply the motor to the drill rig without the need for tools
- Column of the rig can be adjusted to 45°
- Compact combination base – fixing with anchor or vacuum (vacuum pump required)
- Feed handle changeover without any tools – easy change on the jobsite
- Removable wheel axle (accessory) – easy transport

DIAMETER



WET/DRY



GEARS



SPECIFICATIONS	MODEL NO. ETN 162/3 PSA/PSV
Power input	19.5 Amp
Rated voltage	110 V ~
Load speed	0-510/0-1,150/0-2,500 rpm
Drilling diameter	wet ½"-6 ⅜" dry ½"-8"
Spindle connection	⅝" x 11 UNC & 1 ¼" x 7 UNC
Column length	39 ¼"
Hub	27 ⅝"
Weight	34 lbs.

Supplied ETN 162/3 PSA =
 ETN 162/3 + BST 182 V/S
 without drill bit
 ETN 162/3 PSV: Also supplied with vacuum pump

Drill Stand Column

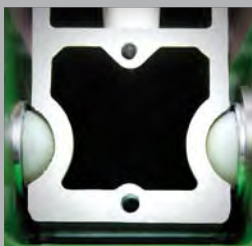

See pages 50-52 for Diamond Core Drill Bits

BST 182 V/S:
 mounted carriage on 4 special balls



The powerful unit for drilling up to Ø 14"

USE:

- Wet drilling in reinforced concrete, natural stone and asphalt
- Civil engineering

FEATURES:

- Powerful 20 Amp motor with high power reserves and a long lifetime
- Electronic – soft start, temperature control and over current cut-off, optical overload indication, constant speed
- Service-LED – lights up approx. 10 working hours before the carbon brushes need to be replaced
- 3 speed oil bath gearbox – for optimal lubrication in all working positions, due to the developed oil pump
- Mechanical safety clutch
- PUR-construction site cable – strong, for heavy duty use
- Universal connection – fasten the motor to the drill rig without any tools
- Integrated spirit level on the carriage, scale and hole center indicator on the drill rig – exact drilling
- Column of the rig can be adjusted to 45°
- Compact combination base – fixing with anchor or vacuum (vacuum set necessary)
- Feed lever change without any tools – easy change on the jobsite
- Removeable wheel axle – easy transport



DIAMOND CORE DRILLING

DIAMETER



WET



GEARS



SPECIFICATIONS	MODEL NO. EBM 352/3 PSA/PSV
Power input	20 Amp
Rated voltage	110 V ~
Load speed	230/500/1,030 rpm
Drilling diameter	14"
Spindle connection	1 1/4" x 7 UNC & 5/8" x 11 UNC
Column length	39 1/4"
Hub	24 1/4"
Weight	77 lbs.

Supplied

EBM 352/3 PSA =
 EBM 352/3 + BST 352 V
 without drill bit

EBM 352/3 PSV: Also supplied with vacuum pump



Drill Stand Column

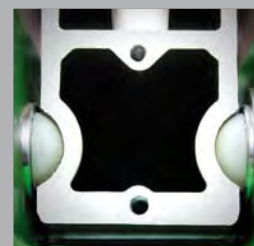

BST 352 V:
 mounted carriage on 4 special balls

See pages 50-52 for Diamond Core Drill Bits



The robust, powerful unit for drilling up to Ø 18"

USE:

- Wet drilling in reinforced concrete, natural stone and asphalt
- Civil engineering

FEATURES:

- Powerful 30 Amp heavy-duty motor with high power reserves and a long lifetime
- Full aluminium housing – durable and resistant
- Electronic – soft start, temperature control and overcurrent cut-off, optical overload indication
- 3 speed oil bath gearbox – for optimal lubrication in all working positions, due to the developed oil pump
- Mechanical safety clutch
- PUR-construction site cable – strong, for heavy duty use
- Universal connection – fasten the motor to the drill rig without any tools
- Integrated spirit level on the carriage and scale on the drill rig – exact drilling
- Column swivel in three levels (75°/60°/45°)
- Steel column – robust, stable, resistant to buckling
- Tooth rail separately exchangeable – easy to maintain
- Compact base with cut-out for quick action bracing unit
- Feed lever change without any tools – easy change on the jobsite
- Removeable wheel axle – easy transport



**POWER REQUIRED
30 AMP, 110V**

DIAMETER

Ø 18"

WET



GEARS



SPECIFICATIONS	MODEL NO. PLD 450 SA
Power input	30 Amp
Rated voltage	110V ~
Load speed	190/400/840 rpm
Drilling diameter	up to 18"
Spindle connection	1¼" x 7 UNC & 5/8" x 11 UNC
Column length	39"
Hub	620 mm
Weight drilling unit	85 lbs

Supplied

PLD 450 SA =
PLD 450 B + PLB 450
without drill bit



**See pages 50-52 for
Diamond Core Drill Bits**



Diamond core drilling units ACCESSORIES

**Diamond drill bits and
drill bit extensions**
see page 51-52

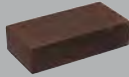

Sharpening block
8" x 4" x 2"



Sharpening stone
12 5/8" x 12 5/8" x 2 1/4"

Spacer block (at DBE 300)
for drillings over Ø 10 1/4"
with 45° inclination

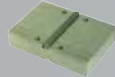

Copper ring 1 1/4"
for easy removing of drill bits
1 piece



Water tank
3 gallon with 3 ft.
hose and Gardena
Connector



251.623

Quick action bracing unit
5 3/8"-9 1/8" Hub



Wheel axle
for PLB 450 Stand



Tightening screw
with wing nut,
washer
1 dowel, Ø 1/2"



Fastening set concrete/stone
tightening screw,
wing nut, washer,
10 dowels, Ø 1/2",
1 punch bolt

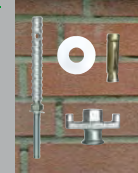

Fastening set brickwork
with Rawl-anchor 1/2", Ø 3/4",
tightening screw with
nut and washer,
wing nut, washer

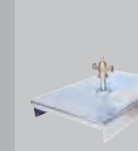

Pipe drilling device
for drill rig



Water suction ring



Spare seals
for water suction ring



**Water Recycling
Vacuum – See page 108**
Model CS 2000 vacuums
slurry and debris,
separates water and
pumps clean water back
to tool. Enables easy
disposal of slurry.



**Industrial Wet/Dry Dust Collec-
tion Vacuums – See page 101**

HEPA Filtration	Standard Filtration
CS 1225 H, 6.6 Gals.	CS 1225, 6.6 Gals.
CS 1500 H, 13 Gals.	CS 1500, 13 Gals.
CS 1445 H, 9 Gals.	CS 1445, 9 Gals.



Vacuum plate
for BST 102, 103, 152



Vacuum plate
for BST 300



Vacuum set
for BST 182 V/S, 352 V



Vacuum hose
Length 9 3/4 ft.



Vacuum pump 253 511
Duty: 25 l/min,
Max. drilling Ø: 6",
Max. vacuum: 850 mbar

Hydraulic Core Drills – Hand-Held and Rig-Mounted

- Rugged 3-speed gearbox with mechanical slip clutch
- Ideal for heavy-duty wet drilling in concrete, reinforced concrete and asphalt
- Self-regulating oil flow control – required volume of 6 GPM; flow up to 13 GPM is automatically bypassed back to the tank
- Hose diameter: 1/2" ID Hose with 3/8" FF (HTMA) Couplings



Model No.	Motor Power (HP)	Max. Drilling Dia.	Free Speed (RPM)	Connecting Threads	Oil Flow/ 2000 PSI	Weight (lbs.)	Stand
2 1317 0030	3.6	6"	380/900/1800	1-1/4"x7 UNC Male 5/8"x11 UNC Male G 1/2" Female	6 GPM	16	N/A
2 1317 0030 SA	3.6	6"	380/900/1800	1-1/4"x7 UNC Male 5/8"x11 UNC Male G 1/2" Female	6 GPM	47	Anchor Stand
2 1317 0030 SV	3.6	6"	380/900/1800	1-1/4"x7 UNC Male 5/8"x11 UNC Male G 1/2" Female	6 GPM	55	Combi Stand and Vacuum Pump
2 1327 0010 SA	4.2	12"	380/900/1800	1-1/4"x7 UNC Male G 1/2" Female Optional: 5/8"x11	6 GPM	69	Anchor Stand
2 1327 0010 SV	4.2	12"	380/900/1800	1-1/4"x7 UNC Male G 1/2" Female Optional: 5/8"x11	6 GPM	82	Combi Stand and Vacuum Pump

Note: Hand-held core drills are intended up to a max. of 3" dia. for hand-held drilling or up to 6" dia. with a stand.

Pneumatic Core Drills – Hand-Held and Rig-Mounted

- Rugged 3-speed gearbox with mechanical slip clutch
- Ideal for heavy-duty wet drilling in concrete, reinforced concrete and asphalt
- Pneumatic power for hazardous areas and Ex zones



Rig-Mounted Model
2 1328 0050 SA



Model No.	Motor Power (HP)	Max. Drilling Dia.	Load Speed (RPM)	CFM@ 90 PSI	Weight (lbs.)	Stand
2 1333 0010	2.1	3"	400/900/1600	77	18	N/A
2 1333 0010 SA	2.1	6"	400/900/1600	77	49	Anchor Stand
2 1333 0010 SV	2.1	6"	400/900/1600	77	51	Anchor Stand & Vacuum Pump
2 1335 0010	3.8	3"	300/700/1350	123	21	N/A
2 1335 0010 SA	3.8	6"	300/700/1350	123	52	Anchor Stand
2 1335 0010 SV	3.8	6"	300/700/1350	123	54	Anchor Stand & Vacuum Pump
2 1328 0050 SA	3.8	12"	300/700/1350	123	66	Anchor Stand
2 1328 0050 SV	3.8	12"	300/700/1350	123	72	Anchor Stand & Vacuum Pump

Note: Hand-held core drills are intended up to a max. of 3" dia. for hand-held drilling or up to 6" dia. with a stand.

Water-Cooled Mini Diamond Core Bits – use with END 712 P + END 1550 P

Mini Diamond Core Bits from 5/32" to 3/4" are water cooled for long service life. Ideal for drilling hard tile, ceramic, granite and concrete.

Note: When using these bits with END 1550 P, Adapter 35122 and Keyless Chuck FFS-M12-M16 are required.

Special Features:

- Easy bit changeover with "Click and Go" keyless chuck
- Drills without cracks or spalding
- Precise holes
- Optional centering aids hold the bit steady and capture slurry

Item No.	Diameter
FF-040851	5/32"
FF-050951	3/16"
FF-065951	1/4"
FF-080951	5/16"
FF-101056	3/8"
FF-121306	1/2"
FF-161306	5/8"
FF-201306	3/4"



Also available: custom-configured diamond matrix and special lengths to correspond to your application – ask us for details!

Unicore Quick-Lock Wet Diamond Core Bits – For use with END 1550 P

Unicore Quick-Lock Bayonet System Wet Diamond Core Bits are ideal for high-performance drilling in concrete, reinforced concrete and natural stone. They are ideal for drilling anchor holes and dowel holes.

Special Features:

- Quick-lock bayonet connector standard (twist lock bayonet system is fast and easy)
- Quick-change bit system allows fast and easy removal of the center core
- Fast penetration coring bits (run at 6000 RPM on END 1550 P)
- Thin wall diamond crown
- Drill through steel rebar in reinforced concrete



Item No.	Diameter
EN38600	3/8"
EN12600	1/2"
EN58600	5/8"
EN34800	3/4"
EN20300	20mm
EN78800	7/8"
EN01800	1"
EN11812	1-1/8"
EN11412	1-1/4"

Also available: custom-configured diamond matrix and special lengths to correspond to your application – ask us for details!

Rebar Cutters



1/2" Chuck with SDS PLUS Shank for Rebar Cutters (for up to 1" dia. cutter) – P/N 2 2409 8999

1/2" Chuck with SDS MAX Shank for Rebar Cutters – P/N XRDCMKL12



Item No.	Dia.
XRC 900	1/2"
XRC 950	9/16"
XRC 1000	5/8"
XRC 1010	11/16"
XRC 1020	3/4"
XRC 1030	7/8"
XRC 1040	1"
RB-108*	1-1/2"

* Not for use in 1" Rotary Hammer Drill

Core Bit Extension Rods for use with Diamond Core Bits

Item No.	Ext.	Thread Connection
4-AEFE-150	6"	5/8" x 11 UNC
4-AEFE-300	12"	5/8" x 11 UNC
4-AEDF-150	6"	1-1/4" x 7 UNC
4-AEDF-300	12"	1-1/4" x 7 UNC
4-AEDF-600	24"	1-1/4" x 7 UNC
4-AEDF-900	36"	1-1/4" x 7 UNC



3/4" Chuck with G 1/2" thread for Rebar Cutters – P/N XRC 775

Unicore Wet Diamond Core Bits – Segmented

Unicore Wet Diamond Core Bits are ideal for high-performance drilling in reinforced concrete and masonry.

Special Features:

- Designed for high performance drilling in reinforced concrete and masonry
- 8mm segment height
- Diamond segments offer faster penetration and long life
- Ideal for all electric, pneumatic and hydraulic drill rigs
- Hand-held applications, less feed pressure required due to segments
- FE (5/8" x 11 UNC) or UF (1-1/4" UNC)

12" Drilling Depth
14" Overall Length



Item No.	Dia.	Max. RPM	Min. RPM
4CB010FE	3/8"	-	-
4CB014FE	1/2"	7960	4775
4CB016FE	5/8"	6368	3820
4CB020FE	3/4"	5307	3183
4CB022FE	7/8"	4549	2728
4CB026FE	1"	3980	2387
4CB030FE	1-1/8"	3538	2122
4CB032FE	1-1/4"	3184	1910
4CB040FE	1-1/2"	2653	1592
4CB045UF	1-3/4"	2274	1364
4CB052UF	2"	1990	1194
4CB065UF	2-1/2"	1592	955

Item No.	Dia.	Max. RPM	Min. RPM
4CB078UF	3"	1327	796
4CB089UF	3-1/2"	1137	682
4CB102UF	4"	995	597
4CB112UF	4-1/2"	884	531
4CB127UF	5"	796	477
4CB152UF	6"	663	398
4CB178UF	7"	569	341
4CB204UF	8"	498	298
4CB228UF	9"	442	265
4CB255UF	10"	398	239
4CB306UF	12"	332	199
4CB314UF	14"	284	171
4CB406UF	16"	249	149
4CB458UF	18"	221	133

Also available: custom-configured diamond matrix and special lengths to correspond to your application – ask us for details!

Threaded Diamond Core Bits and Barrels for Deep Drilling

- Designed for deep drilling in reinforced concrete and masonry
- Ideal for electric, pneumatic and hydraulic drill rigs
- Threaded barrels from 12" to 48" long
- 1" through 6-1/2" dia. threaded bits have a .187" segment
- 7" through 10" dia. threaded bits have a .250" segment

Also available: custom-configured diamond matrix to correspond to your application – ask us for details!



Ideal for special applications

Dia.	Threaded Diamond Bit	1-1/4" x 7 Threaded Cap	12" Core Barrel	24" Core Barrel	36" Core Barrel	48" Core Barrel
1"	TCB026	TCB026-CAP	TCB026-12	TCB026-24	TCB026-36	TCB026-48
1-1/4"	TCB032	TCB032-CAP	TCB032-12	TCB032-24	TCB032-36	TCB032-48
1-1/2"	TCB040	TCB040-CAP	TCB040-12	TCB040-24	TCB040-36	TCB040-48
2"	TCB052	TCB052-CAP	TCB052-12	TCB052-24	TCB052-36	TCB052-48
2-1/4"	TCB057	TCB057-CAP	TCB057-12	TCB057-24	TCB057-36	TCB057-48
2-1/2"	TCB065	TCB065-CAP	TCB065-12	TCB065-24	TCB065-36	TCB065-48
3"	TCB078	TCB078-CAP	TCB078-12	TCB078-24	TCB078-36	TCB078-48
3-1/2"	TCB089	TCB089-CAP	TCB089-12	TCB089-24	TCB089-36	TCB089-48
4"	TCB102	TCB102-CAP	TCB102-12	TCB102-24	TCB102-36	TCB102-48
5"	TCB127	TCB127-CAP	TCB127-12	TCB127-24	TCB127-36	TCB127-48
6"	TCB152	TCB152-CAP	TCB152-12	TCB152-24	TCB152-36	TCB152-48
7"	TCB178	TCB178-CAP	TCB178-12	TCB178-24	TCB178-36	TCB178-48
8"	TCB204	TCB204-CAP	TCB204-12	TCB204-24	TCB204-36	TCB204-48
9"	TCB228	TCB228-CAP	TCB228-12	TCB228-24	TCB228-36	TCB228-48
10"	TCB255	TCB255-CAP	TCB255-12	TCB255-24	TCB255-36	TCB255-48

Unicore Dry Diamond Core Bits – Segmented

Special Features:

- Quickly drills through block and brick with no water
- 7mm segment height
- Diamond segments offer faster penetration and long life
- 5/8" x 11 female thread
- Hand-held applications, less feed pressure required due to segments

9" Drilling Depth



Item No.	Size Description 5/8"-11	Max. RPM	Min. RPM
4CB026-Dry	1" dia. X .110	6000	2300
4CB032-Dry	1-1/4" dia. X .110	6000	2300
4CB040-Dry	1-1/2" dia. X .110	5000	1600
4CB045-Dry	1-3/4" dia. X .110	5000	1600
4CB052-Dry	2" dia. X .118	5000	1200
4CB057-Dry	2-1/4" dia. X .118	5000	1200
4CB065-Dry	2-1/2" dia. X .118	5000	1200
4CB078-Dry	3" dia. X .118	5000	800
4CB089-Dry	3-1/2" dia. X .118	5000	800
4CB102-Dry	4" dia. X .125	5000	700
4CB108-Dry	4-1/4" dia. X .125	5000	700
4CB112-Dry	4-1/2" dia. X .125	5000	700
4CB127-Dry	5" dia. X .125	3500	700
4CB152-Dry	6" dia. X .125	2500	600

Dry Diamond Vacuum Bits – for cured concrete and masonry

Dry vacuum bits are for cured concrete and masonry. They are not used in reinforced concrete where the steel is heavier than wire mesh. Dry vacuum bits must be used with a dry vacuum swivel.

Special Features:

- Quickly drills through block and brick with no water
- Drill depth up to 9"
- Diamond segments offer faster penetration and long life
- 1-1/4 - 12 female threaded hub
- Hand-held applications, less feed pressure required due to segments

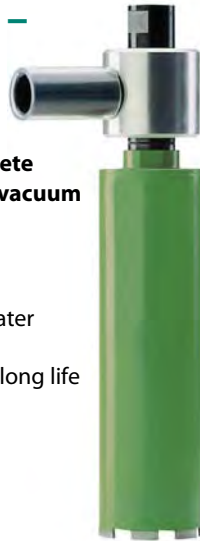

Item No.	Dia.	Max. RPM	Min. RPM
4CB026-DVB	1"	6000	2300
4CB032-DVB	1-1/4"	6000	2300
4CB040-DVB	1-1/2"	5000	1600
4CB045-DVB	1-3/4"	5000	1600
4CB052-DVB	2"	5000	1200
4CB057-DVB	2-1/4"	5000	1200
4CB065-DVB	2-1/2"	5000	1200
4CB078-DVB	3"	5000	800
4CB089-DVB	3-1/2"	5000	800
4CB102-DVB	4"	5000	700
4CB112-DVB	4-1/2"	5000	700
4CB127-DVB	5"	3500	700
4CB152-DVB	6"	2500	600



Air Swivel for Dry Diamond Vacuum Bits

4400125

Carbide-Tipped Plate Cutters

- Designed for use in a core drill when a combination of concrete and steel is being drilled
- Cuts through steel plate, embedded rebar, or even wire mesh
- Can be used wet with a small amount of water, or dry
- Withstands rough usage

Note: All diameters are nominal, exact tolerances upon request.

Carbide-Tipped Plate Cutters

- 11" Usable Length
- 13-1/2" Overall Length
- 5/8"-11 hub thread size

Carbide-Tipped Plate Cutters

- 12" Usable Length
- 14-3/4" Overall Length
- 1-1/4" x 7 hub thread size



DIAMOND CORE DRILLING

Item No.	Dia.
CSPC-1202	1/2"
CSPC-1203	5/8"
CSPC-1204	3/4"
CSPC-1205	7/8"
CSPC-1206	1"
CSPC-1207	1-1/8"
CSPC-1208	1-1/4"
CSPC-1209	1-3/8"
CSPC-1210	1-1/2"
CSPC-1211	1-5/8"

Item No.	Dia.
CSPC-1212	1-3/4"
CSPC-1278	1-7/8"
CSPC-1213	2"
CSPC-1221	2-1/4"
CSPC-1214	2-1/2"
CSPC-1215	2-3/4"
CSPC-1216	3"
CSPC-1222	3-1/4"
CSPC-1217	3-1/2"
CSPC-1218	3-3/4"
CSPC-1223	4"

Item No.	Dia.
CSPC-1224	4-1/4"
CSPC-1219	4-1/2"
CSPC-1225	5"
CSPC-1220	5-1/2"
CSPC-6500	6"
CSPC-7000	7"
CSPC-8000	8"
CSPC-9000	9"
CSPC-1000	10"
CSPC-1100	11"
CSPC-1200	12"

CS 2000 Water Recycling and Slurry Containment Vacuum

Separates water and contains slurry

Ideal for core drills and other concrete power tools. Vacuums slurry and debris, separates water and pumps clean water back to tool. Enables easy disposal of slurry.

See page 108 for more details.



CS 2000 Water Recycling System:

- Portable Water Supply
- Wet/Dry Vacuum
- Slurry Containment System

Ideal for use with Concrete Core Drills and other Wet-working Tools

The **CS 2000** saves time and money, benefiting both the environment and your bottom line.

Work Faster – With both a portable water supply and a continuous loop system, you will conserve water and save time normally used for refilling portable pumps.

Work Cleaner – The slurry containment and vacuum system keeps the work area clean and dry – spend less time cleaning up. Ideal for indoor and outdoor applications such as hospitals, office buildings, factories, patios and more.

Work More Environmentally Friendly – Slurry is contained in a porous filter bag, allowing for safe, easy, proper waste disposal.

FEATURES:

- Powerful 17 amp motor, 7 gallon water capacity
- Integrated sump pump delivers water from tank to tool
- Vacuum suction brings water back to the tank into a porous filter bag
- Slurry and debris are captured and the clean water flows back into the tank for delivery back to the tool
- Slurry contained in a porous filter bag, allowing for safe, easy, proper waste disposal
- Continuous loop system conserves water and saves time when compared to refilling portable pumps



Model CS 2000 and attachments



The CS 2000 vacuum features:

Integrated Submersible Sump Pump with Replaceable Filter Sleeve

Powerful, robust operation has a flow rate of 78 GPM at level and a maximum water lift of 18 feet. Delivery is 10.5 GPM at 10 feet.

Secure, Reliable Connections

Power cable plug for sump pump and water recycling or discharge hose connection.

Heavy-duty Seals

Heavy-duty plugs seal vacuum for normal wet/dry cleaning and transport.



SPECIFICATIONS	MODEL NO. CS 2000
Power	17 Amp, 115 VAC/60Hz, 1-phase (includes 11 Amp Vac motor and 6 Amp sump pump)
Water capacity	7 gallons
Pump output	78 GPM at ground level 10.5 GPM at 10 ft. discharge height
Water lift	18 ft. max. discharge height
Water pressure	14.5 PSI (pump delivery)
Air flow	150 CFM
Canister volume	13 gallons
Canister	Stainless steel tank with cart
Dimensions	20.5" W x 21.6" L x 39.5" H
Weight	59 lbs.
Supplied	Vacuum hose, water recycling/discharge hose, slurry filter bags and owner's manual



Above: Integrated sump pump can recycle or discharge water.



Two switches operate motor and pump independently. Power socket for integrated sump pump.



When wet drilling, cutting or grinding, water can be continuously pumped to the work area, then vacuumed and filtered in the tank.

Water collection ring allows vacuum attachment.



Stainless steel canister can either be tilted (left) or lifted out of cart (right).

Large wheels, locking front casters, 26-ft. power cord and removable handle allow for easy maneuverability and transport.



See page 108 for accessories and more information.