

Model HB 4400 – Hydraulic Magnetic Drill

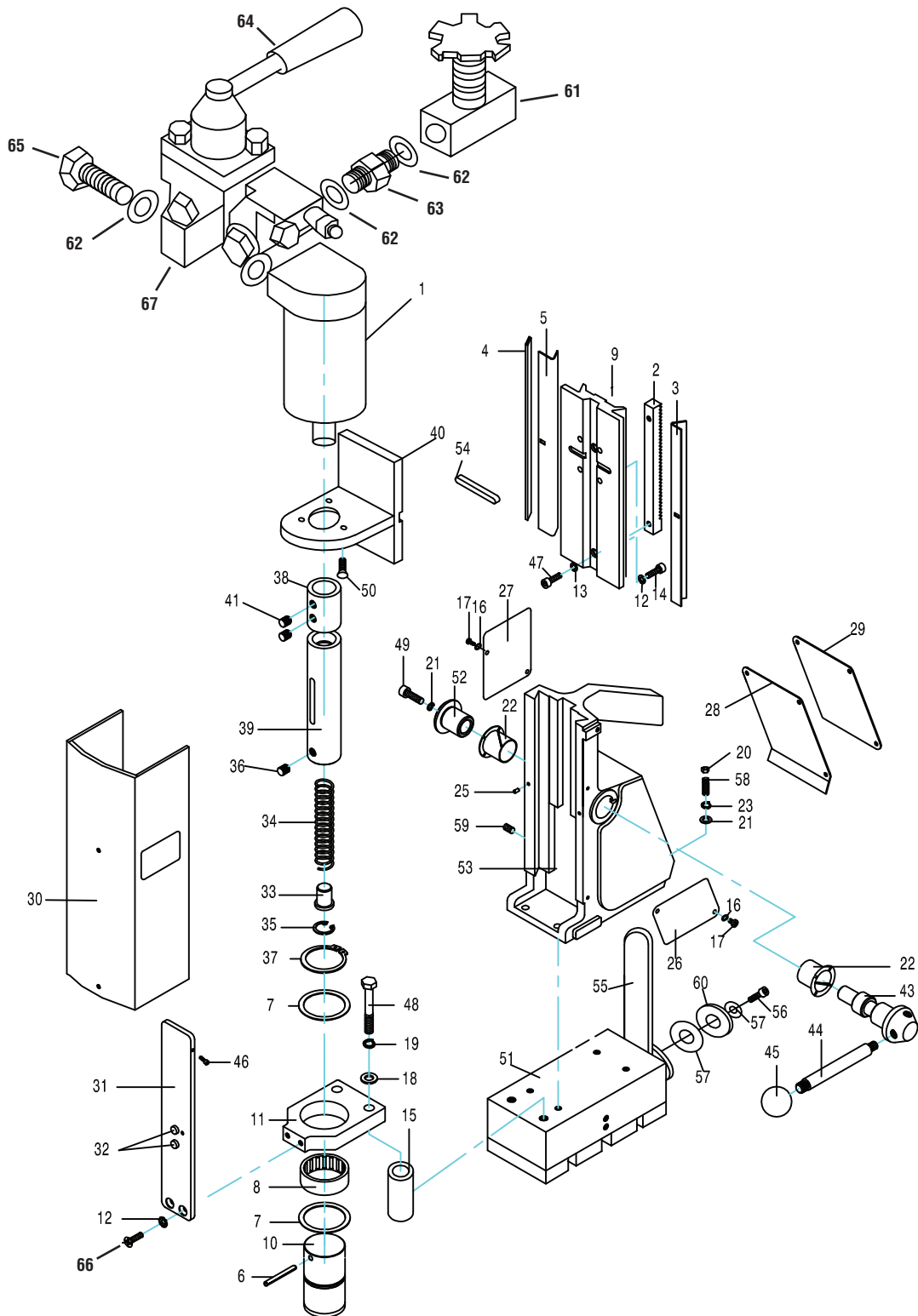

CS UNITEC, INC.
22 Harbor Avenue • Norwalk, CT 06850
Toll-free: 800-700-5919 • 203-853-9522
Email: info@csunitec.com
www.csunitec.com

Model HB 4400 – Hydraulic Magnetic Drill



Pos. No.	Description	Item No.	Pos. No.	Description	Item No.
1	Motor Control Module Includes:	RD2365	33	Button	RA354
	Flat face coupling 1/2" BSP	RD43331	34	Spring	RA355
	Flat face plug 1/2" BSP	RD43332	35	Circlip	RD4056
	Male adaptor 3/8" x 1/2" BSP	RD43333	36	M8 Socket Screw	RD4066
	Bonded Dowty Seal	RD43334	37	External Circlip	RD4320
	Bonded Dowty Seal	RD43335	38	Arbor adaptor	RD33024
2	Rack	RD3350	39	Arbor	RD33021
3	Fixed Gib Strip	RD3317	40	Motor Bracket	RD3395
4	Adjustable Gib Strip	RD3316	41	M8 Socket Screw dog point	RD43135
5	Gib Support Strip	RD3310	42	O ring	RD43136
6	Spirol Pin	RA353	43	Capstan Pinion Shaft	RD33088
7	Thrust Washer	RA401	44	Capstan Arm	RD33089
8	Nylon Bearing	RD350	45	Plastic Knob	RD43091
9	Slide	RD3381	46	M3 Socket Head Screw	RD43130
10	Arbor Sleeve	RD3396	47	M6 Socket Head Cap Screw	RD43128
11	Bearing Bracket	RD3389	48	M8 Socket Head Set Screw	RD43127
12	M5 Shakeproof Washer	RD4092	49	M6 Socket Head Screw	RD43126
13	M6 Shakeproof Washer	RD4096	50	M5 x 16 Countersink Socket Screw	RD43131
14	M5 Socket Head Screw	RD4325	51	Magnet (includes Pole Piece Set) and Pos. 55/56/57 & 60	RD43100
15	Bearing bracket Spacer		52	Pinion Shaft Sleeve	RD33090
16	M4 Shakeproof Washer	RD4340	53	Housing	RD3380
17	M4 Panhead screw	RD4069	54	Key	RD3009
18	M8 Washer	RD4077	55	Ratchet Handle	RD43049
19	M8 Shakeproof Washer	RD4078	56	M6 Socket Head Screw	RD43126
20	M6 Nut	RD4079	57	M6 Washer	RD33030
21	M6 Washer	RD4087	58	M6 Stud	RD4340
22	Nyliner Bearing	RD4313	59	Screw	RD4312
23	M6 Spring Washer	RD4095	60	Ratchet handle washer	RD33030
24	M6 Socket Screw	RD4207	61	Needle Valve	RD 43050
25	Tension Pin	RD4312	62	Seal	RD 43052
26	Name Plate	RD4102	63	3/8" Equal Nipple	RD 43051
27	Information Plate	RD43010	64	Handle for HB 4400 Motor	RD 43055
28	Cover Plate	RD4362	65	Hex Bolt	RD 43056
29	Identity Plate	RD33017	66	Countersink Socket Screw	RD 4338
30	Guard	RD3397	67	Motor Control Module (includes Pos. 64 & 65)	RD 43043
31	Guard Bracket	RD33000			
32	Spring Plunger	RD4346			

CS UNITEC, INC.
 22 Harbor Avenue • Norwalk, CT 06850
 Toll-free: 800-700-5919 • 203-853-9522
 Email: info@csunitec.com
www.csunitec.com